

emco



**High-performance turning/milling
center for complete machining**



HYPERTURN 65 PM

/ HIGH- PERFORMANCE TURNING/MILLING CENTER

More clearance, more power, more possibilities: with a spindle distance of 1300 mm, a powerful counter spindle which also allows 4-axis machining, a B-axis with a direct drive for complex 5-axis simultaneous milling operations, an additional Y-axis for the lower turret, and all proven, high-quality features of the Hyperturn series, the Hyperturn 65 Powermill is a powerful addition to every machine range.



Sprocket-wheel (Steel Ck 45)

1 UPPER Y-AXIS

- / Large working stroke +120 / -100
- / Short projection length
- / Pre-loaded roller guides
- / Wide guide clearance

2 UPPER TOOL SYSTEM

- / Powerful milling spindle 22 kW
- / Wide speed range 0-12000 rpm
- / Water-cooled motor spindle with HSK-T63
- / Internal and external coolant supply
- / B-axis with zero backlash direct drive
- / B-axis position can be clamped in any position

3 MAIN SPINDLE

- / Water-cooled Integrated Spindle Motor (ISM) in synchronous technology
- / High drive power 29 (37) kW
- / High torque 250 (360) Nm
- / Large speed range 0 - 5000 (4000/3500) rpm
- / Highly dynamic
- / Bar capacity diameter 65 (76/95) mm

4 TOOL MAGAZINE

- / 20-slot disc-type tool magazine
- / 40/80-slot chain-type tool magazine
- / Ergonomically arranged at the front
- / Easy to be manually loaded with tooling
- / Max. tool length 250 mm
- / Max. tool diameter 80 (120) mm
- / Max. tool weight 5 kg

5 LOWER TOOL SYSTEM

- / 12-station tool turret
- / VDI30- (VDI40- or BMT55P-) quick-change system
- / 12 driven tool stations
- / Servo-controlled
- / Rigid tapping
- / Polygonal turning, etc.

6 LOWER Y-AXIS

- / Travel +/- 50 mm
- / Stable, compact construction
- / Wide guide clearances
- / Wedge carriage system

7 COUNTER SPINDLE

- / Water-cooled Integrated Spindle Motor (ISM) in synchronous technology
- / High drive power 29 kW
- / High torque 250 Nm
- / Wide speed range 0-5000 rpm
- / Internal coolant supply for flushing
- / Automatic part ejector

8 CHIP CONVEYER

- / Hinged type conveyor belt
- / Throw-off height 1200 mm
- / Integrated coolant tank 400 l
- / Turret pumps: 2 x 14 bar
- / Flushing pumps: 2 x 3.7 bar

9 CONTROL UNIT

- / Ergonomically designed
- / 90° swivelling
- / Height adjustment: 100 mm
- / Lateral adjustment: 300 mm
- / Siemens Sinumerik
- / 22" multi-touch display incl. IPC

10 WORK AREA

- / Generous design
- / Straight chip fall
- / Optimum access to the work area



DESIGN

1 MACHINE DESIGN

- / Two-piece base structure with machine base and machine bed
- / Torsion-resistant welded steel construction
- / Machine bed filled with special concrete HYDROPOL
- / Rigid welded steel construction

2 ROLLER GUIDES

- / In all linear axes
- / Large distance between the guides
- / Large guide ways

3 MAIN SPINDLE

- / Large speed range
- / C-axis for milling operations
- / Additional holding brake
- / KK 6 (8) spindle connection
- / Hollow clamping system with clamping stroke control

4 COUNTER SPINDLE

- / Large speed range
- / C-axis for milling operations
- / Additional holding brake
- / KK 6 (8) spindle connection
- / Full clamping system with clamping stroke control
- / Coolant-flooded parts ejector with stroke control

5 MILLING SPINDLE

- / Powerful milling spindle (22 kW)
- / Large speed range (0 - 12000 rpm)
- / Water-cooled motor spindle with HSK-T63
- / Internal and external coolant supply
- / Can be clamped at any angle

6 TOOL TURRET

- / 12-stations VDI30 with quick change system
- / All stations can hold driven tools
- / Optionally available with VDI 40 interface
- / Optionally available with BMT55P interface and water-cooled direct drive

7 TOOL MAGAZINE

- / 20-slot disc-type magazine with pick-up tool changer
- / 40 or 60-station chain magazine with swivel tool changer
- / Variable or fixed tool station assignment
- / Max. tool length 250 mm
- / Max. tool diameter 80 (120) mm
- / Max. tool weight 5 kg

8 TOOL CHANGER

- / Servo-controlled swing-arm-type tool changer
- / Short changing times
- / Trouble-free operation

9 FINISHED PART CONVEYOR

- / Max. work piece size $\varnothing 95 \times 200$ mm
- / Max. finished part weight 4,5 kg
- / Storage area 1400 x 180 mm

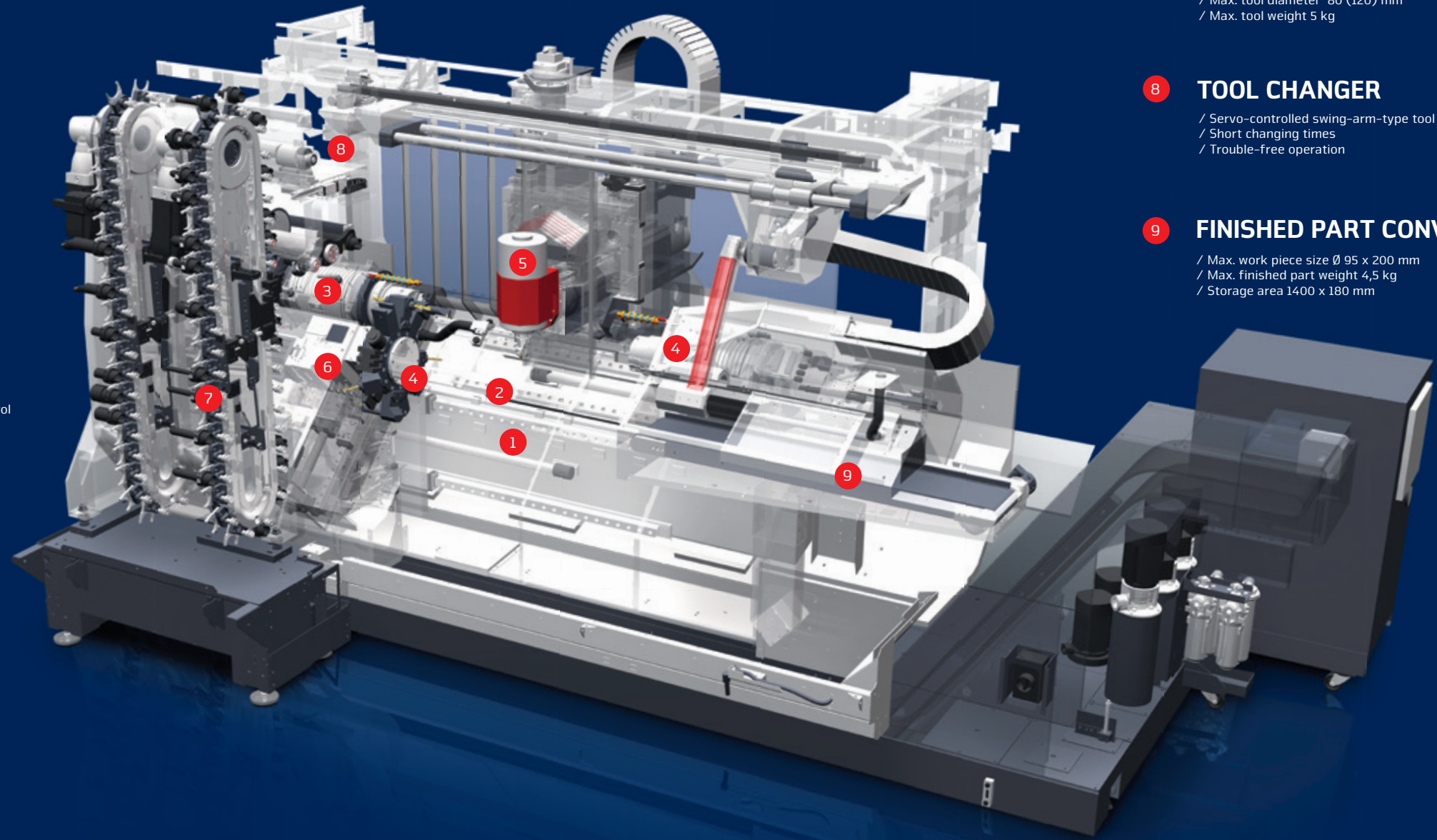

POWER AND TORQUE

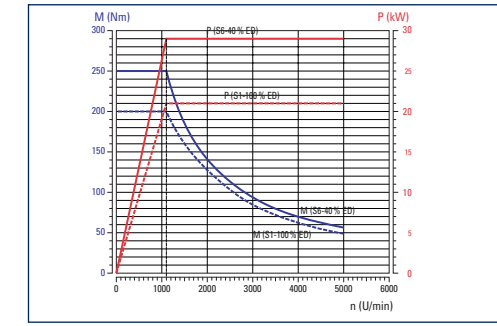

Main and counter spindle $\varnothing 65$ mm / $\varnothing 76$ mm

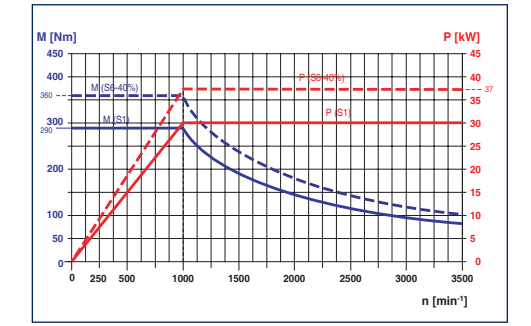

Main spindle $\varnothing 95$ mm

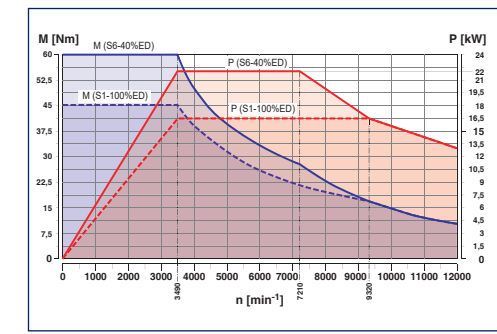

Milling spindle with max. 12000 rpm

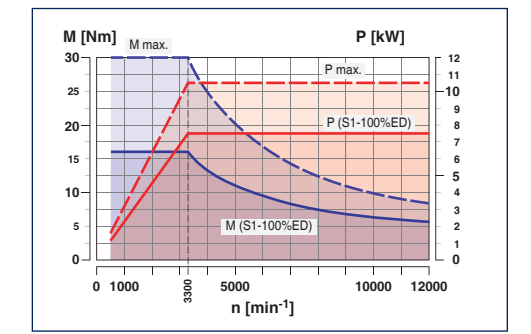

Direct milling drives in tool turret with BMT55P

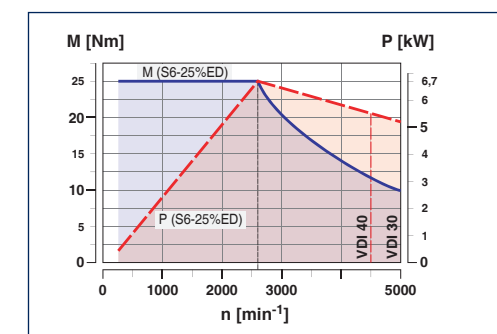

Milling drives in tool turret with VDI 30/40

TECHNICAL HIGHLIGHTS

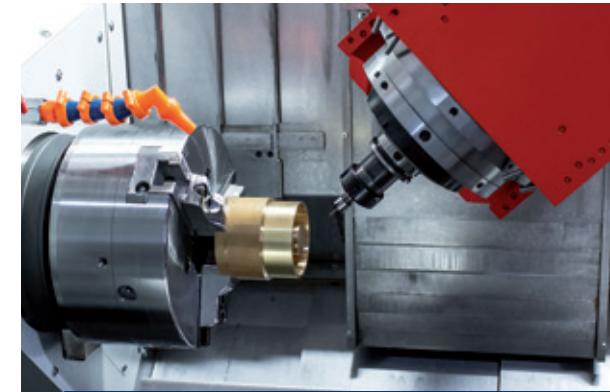
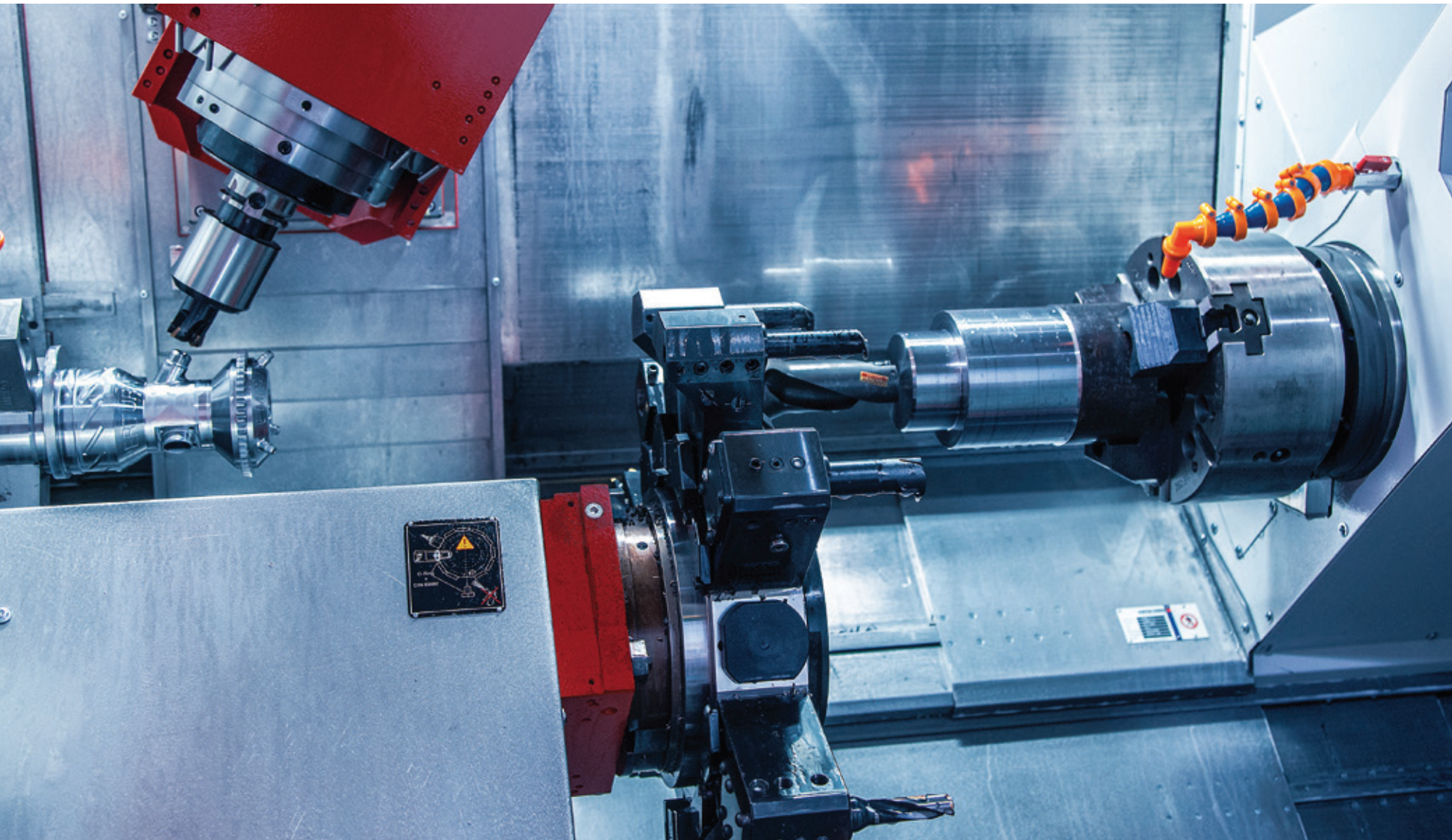

MAIN SPINDLE

With an output of 29 (37) kW and 250 (360) Nm torque, the main spindle is powerful enough to machine from bar-stock up to a diameter of 65 (76/95) mm and chuck parts up to a diameter of 250 mm. A mechanical clamp brake ensures additional stability for high-performance milling.



MILLING SPINDLE

At 22 kW and 60 Nm and a max. speed of 12000 rpm, the HYPERTURN 65 Powermill supports state-of-the-art milling processes such as HSC or HPC. This means that complex turned and milled parts can be produced in an extremely efficient manner.



MANUAL TOOL CHANGING

Tools can be loaded into the tool magazines from the front. This avoids the need for the user to go to the rear of the machine. Also tool wear or break inspections can be handled in a time-saving way.

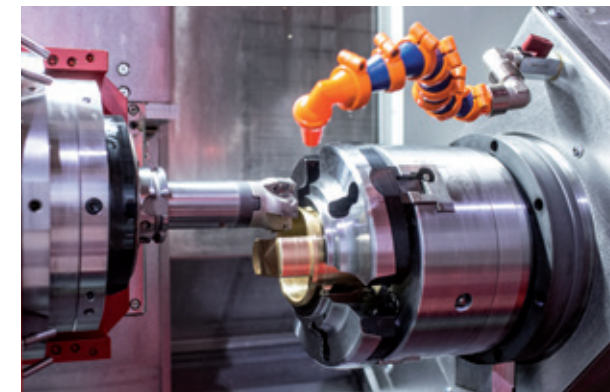

COUNTER SPINDLE

The moving counter spindle offers identical performance data to the main spindle. The mechanical disc brake is also included in the basic equipment level. Additionally, a stroke-monitored part ejector that is flooded with coolant is integrated into the spindle. This ensures a reliable, unmanned machining process.



HOLDING BRAKE ON THE MAIN AND COUNTER SPINDLE

It is always the respective C-axis which is positioned for milling and drilling operations. Additionally, however, it is possible to clamp each spindle in any position.



CONTROL UNIT

On the Hyperturn 65 Powermill, the Sinumerik control unit is located on the right side of the work area in a swiveling panel. This ensures maximum ergonomics for setting up and running in the machine.

TECHNICAL HIGHLIGHTS

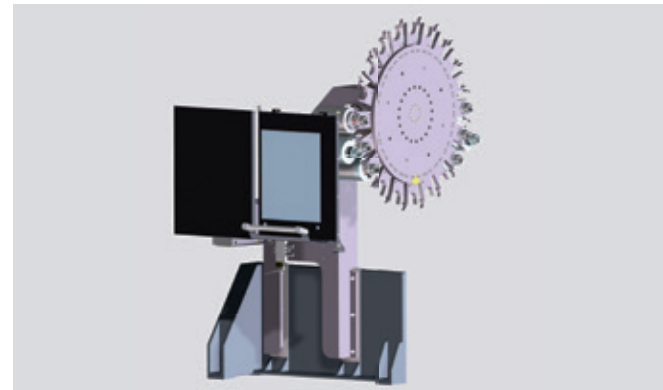
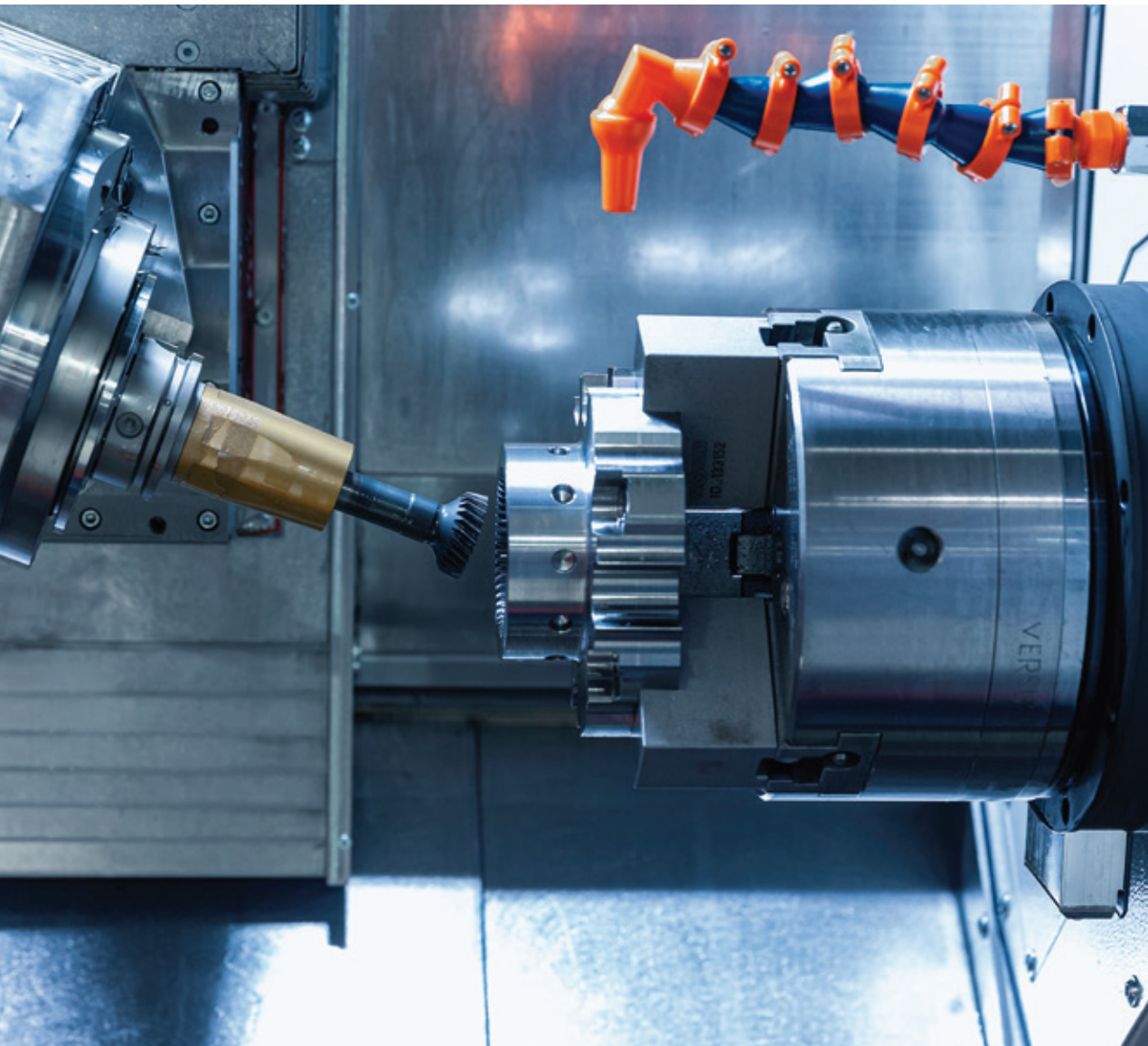

20-SLOT MAGAZINE

The tools are stored in a 20-slot tool disc. The milling spindle simply puts the last tool into an empty position, indexes to the next tool and picks it up.

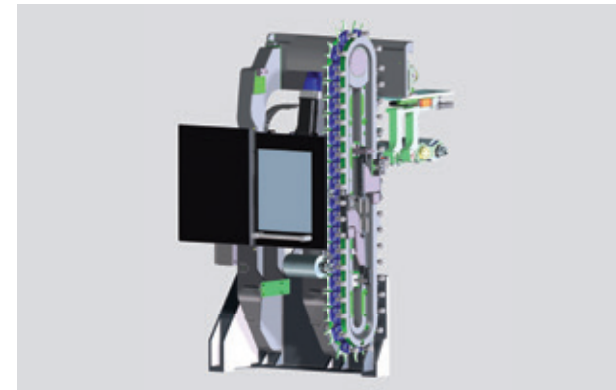

40-SLOT MAGAZINE

The chain magazine can hold up to 40 tool holders with HSK-A63 and HSK-T63 shafts. A swivel arm changer is used to change the tool into the milling spindle.

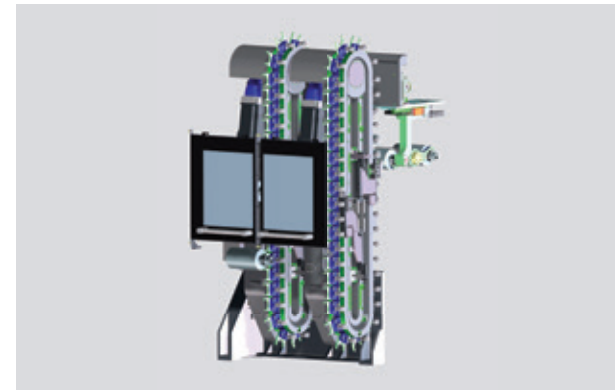

80-SLOT MAGAZINE

Two 40-slot chain magazines can be used for up to 80 tool holders HSK-A63 and HSK-T63 shafts. Due to the large stock of tools, the tooling times are reduced to a minimum. The tool cabinet is basically built into the machine.



CLAMPING STROKE CONTROL ON THE MAIN AND COUNTER SPINDLE

Thanks to the programmable clamping stroke control, the clamping positions of the two clamping cylinders can be easily taught in. As a consequence, handling works on the cylinders are no longer required. This leads in turn to shorter set-up times.



PARTS EJECTOR ON THE COUNTER SPINDLE

The parts ejector on the counter tray is used to push the finished part into the collection tray. Reaching the front end position is monitored. What is more, the ejection tube is flushed with coolant to clean the clamping device / workpiece.



WORK AREA

Telescopic panels with force-guided scissor kinematics guarantee smooth feed movements, even at high travel speeds. The results: perfect workpiece surfaces and covers with an increased service life.

HIGHLIGHTS

- / High dynamics thanks to cutting-edge spindle motor technology
- / Maximum thermostability thanks to liquid-cooled spindles
- / High productivity thanks to short tool changing times
- / Both tool systems can be used on both spindles
- / Machine bed construction for maximum stability and vibration absorption
- / Excellent repeatability thanks to linear guides
- / Short setup times thanks to an easily accessible work area



COMPRESSED AIR PISTOL

Located on the side of the machine, the spiral hose with compressed air pistol can be used to clean workpieces, clamping devices and workpiece holders.

NETWORKS ARE CREATED INDIVIDUALLY – OUR SOLUTIONS AS WELL



Staying in touch is important not only among human beings. Persons, machines and the whole production environment must also be connected perfectly and safely in order to ensure efficient procedures during the production process. With EMCONNECT, the machine is optimally equipped for this purpose. The optional EMCONNECT Digital Services offer innovative online services for optimized machine operation. The user has always the control of the machine status. The automatic notification in case of malfunctions or standstill of the machine as well as the extended capabilities for remote maintenance, minimise downtimes.

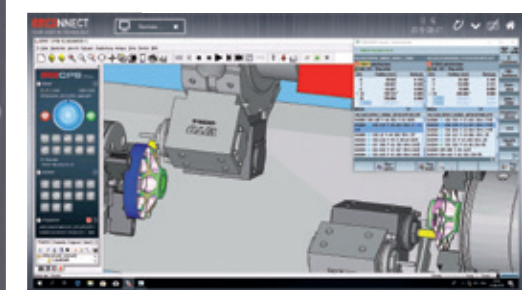

Integration into control

EMCONNECT offers several possibilities of operation according to different situations. For quick access, apps may be used simultaneously in the side panel of controlling. In this way, you can always look at your familiar numerical control, the well-known centrepiece of the machine.

An innovative concept

These powerful apps may be used independently from the control, while in the background the machine is busy in the production process. With only one click, you can change at any moment between numerical control and EMCONNECT. This is possible with the help of an innovative and ergonomic control panel, equipped with a modern 22" multi-touch display, an industrial PC with associated keyboard and HMI hotkeys.



The control panel as central platform

With EMCONNECT, the control panel of the machine becomes the central platform for the access to all the operative functions. The user gets every type of support from the apps, which directly provide all the necessary applications, data and documents. In this way, EMCONNECT makes an important contribution to a highly efficient processing at the machine.



Comprehensive connectivity options

With the remote support, the web browser and the remote desktop, there are numerous connectivity options, even beyond the direct production environment. With the help of the integrated remote support, it is easily possible to carry out the remote diagnosis and remote maintenance. The optionally available OPC UA interface enables data exchange with the IT system environment and interaction with other machines for automation at shop floor level.

EMCONNECT HIGHLIGHTS AND FUNCTIONS

- / Fully connected**
Connection to all applications via remote control of the office computer and the web browser
- / Structured**
Clear monitoring of the machine state and the production data
- / Customized**
Open platform for modular integration of customer-specific applications
- / Compatible**
Interface for seamless integration into the operating environment
- / User-friendly**
Intuitive and production-optimized touch operation data
- / Future-proof**
Continuous extensions as well as easy updates and upgrades

Standard-Apps

Control	Dashboard
Machine Data	System
Remote Desktop	Web Browser
Remote Support	Settings
Cutting Calculator	Calculator
Notes	Service
Documents	EMCO TechSheet
GD&T	File Import
Shopfloor Data	Thread Reference
	Tricalc

Optional

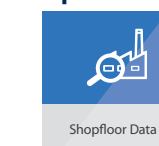



/ Ing. Johann Brisker
Brisker GmbH

"All EMCO turning machines are automated with short bar or bar loaders, which frees up employees for other tasks and, as a consequence, increases productivity."

The EMCO short bar loaders. Universal and powerful.



SHORT AND TO THE POINT.

The EMCO SL1200 is the perfect solution for automatic feeding and loading of cut-to-length bars. The key advantages are a small footprint and rapid loading times resulting from shorter strokes.

The technology. The EMCO SL1200 can be used immediately as a "plug-and-play" solution. Their extremely small footprint enables processes to be automated even if space is tight. Apart from complying with the latest safety requirements, it is easy to operate and

moveable for service purposes. Besides, it can comfortably be incorporated into the production process using the machine control's programme input masks. Minimum setup efforts are required when switching over to other bar diameters.



EMCO SL1200

Space-saving and cost-effective bar loading magazine. Operation and programming could not be easier. May also be used for loading single items through the lathe's main spindle.



MATERIAL STORAGE

The material storage surface with a length of 560 mm is arranged at the rear of the bar loader in a manner with no influence whatsoever on the space available. Depending on the diameter it is possible to store a different number of short bars.

THE BENEFITS

- / Small footprint
- / Easy to use
- / Short feed times
- / Fast, straightforward changeover
- / Option to load individual workpieces
- / Central diameter adjustment
- / The loader operates without oil
- / Ergonomic EMCO design

Technical data	SL1200
Bar diameter	Ø 8 – 95 mm
Max. bar length	1200 mm
Min. bar length	150 mm
Max. bar weight	45 kg
Material storage length	approx. 560 mm
Feed rate	0 – 60 m/min
Bar change time	approx. 15 sec.
Dimensions (L x W)	1700 x 1250 mm
Weight	approx. 500 kg

THE EMCO GANTRY LOADER. INDIVIDUAL PROCESS OPTIMIZATION.

- 1 GANTRY LOADER
- 2 PALLET MAGAZINE (20 stations)
- 3 GRIPPER SYSTEM



ADVANTAGES

- / Fully automatic loading and unloading of the workpieces
- / Multi-channel Sinumerik control incl. user cycles
- / Seamless interplay between the machine tool and the loading device
- / Varied possibilities of customer-specific adaptation
- / Possibility of integration of measuring station, signing station, cleaning station, etc.
- / Short non-productive times due to a loading hatch

AUTOMATIC RETURN ON INVESTMENT

Workpiece magazine

Blank-specific pallet attachments enable oriented loading of blanks into the machine and increase the parts stock for unmanned production. Changeover times are reduced or eliminated thanks to the perfect adjustment to the customer's parts.



4-station pallet attachment for tees

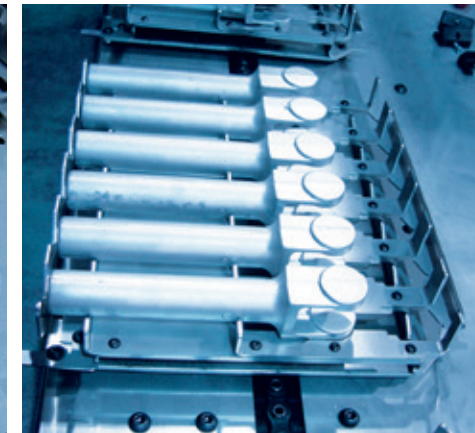

6-station pallet attachment for articulated brackets

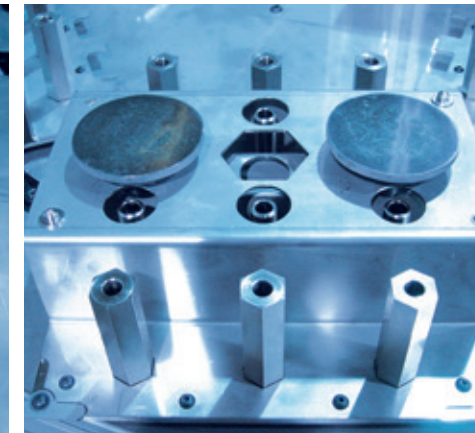

Multi-pallet attachment for a family of parts



4-station pallet attachment for valve caps



20-station pallet magazine with customer-specific pallets



2 x 3-jaw double gripper head

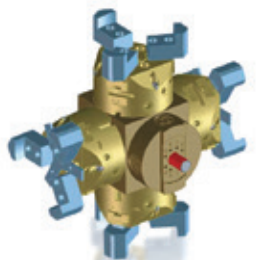

4 x 3-jaw gripper head

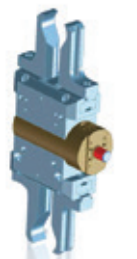

Shaft gripper head

/ OPTIONS

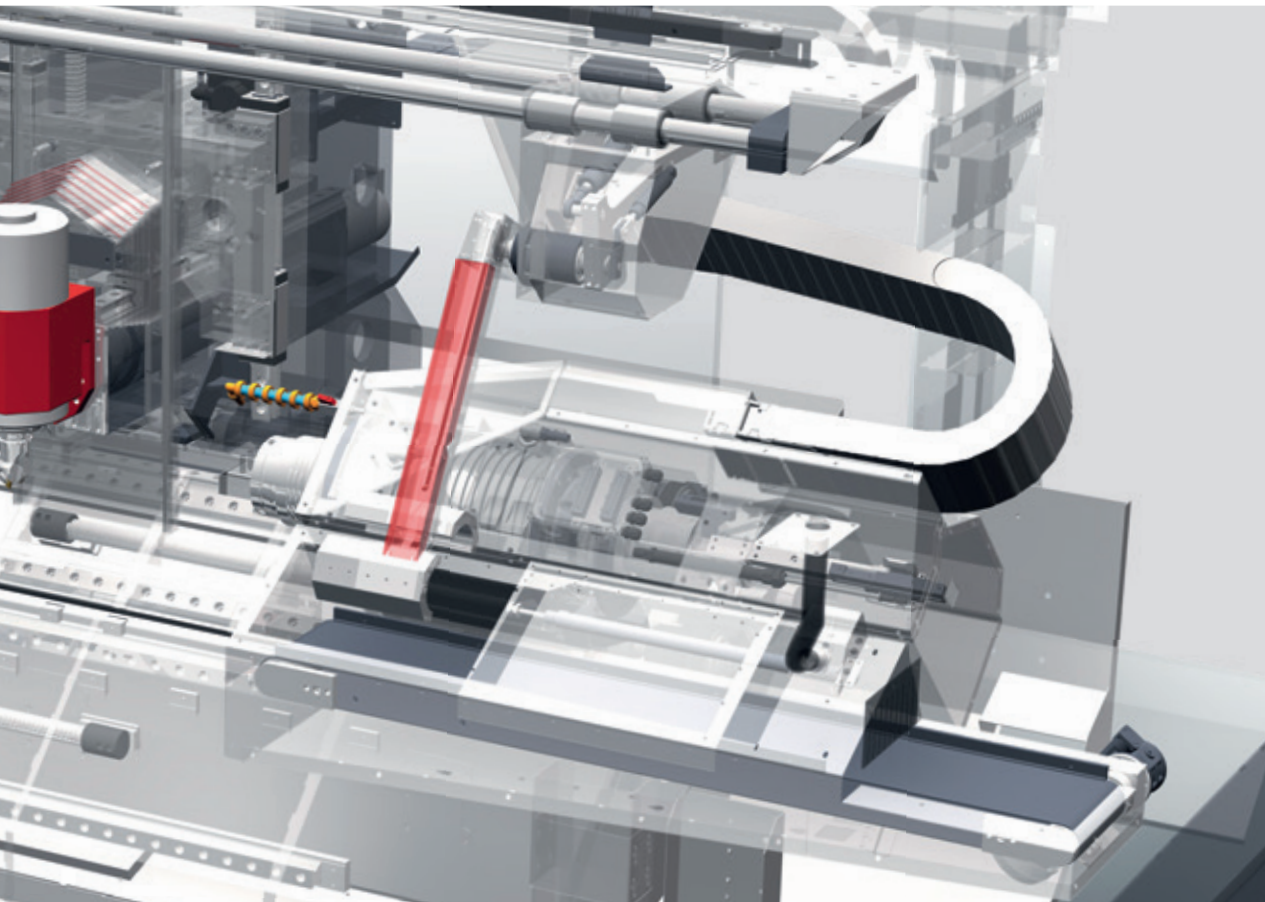

WORKPIECE PICKUP DEVICE WITH ACCUMULATING CONVEYOR

The electro-pneumatic pickup device is programmed via M functions. The travel movement is implemented via an electric motor. If required, the pickup device can thus drive as far as the main spindle and pick up any remaining bar material. Most of the time, however, the finished part is collected from the counter spindle and then placed onto the finished parts conveyor belt. Using two half shells, it is possible to unload a wide range of finished parts without any setup effort. The parts ejector in the counter spindle pushes the workpiece into the pickup device.



PICKUP DEVICE

The pickup device unloads the finished part onto an accumulating conveyor. To this end, a covering hood is briefly opened and immediately closed again. When the pickup device is in its normal position, it does not have any influence whatsoever on the machining process.



TOOL MEASUREMENT

Using the tool measurement sensor, the tools inside the work area can be measured in a quick and straightforward way. It is manually fixed to the holder below the main spindle and placed into a storage space after use.

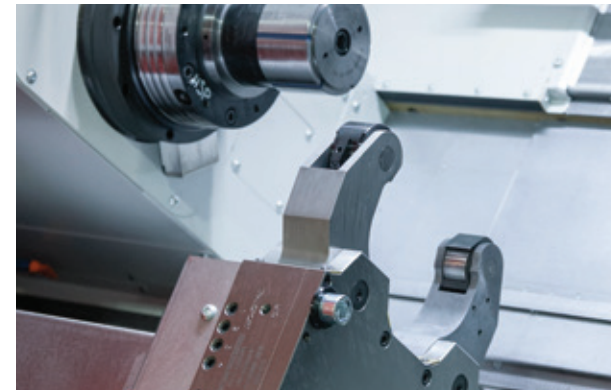

CNC STEADY REST

Several steady rests are available for shaft machining. Small shaft parts can be supported with a turret-mounted steady rest. A CNC steady rest featuring a centring range from 25 to 280 mm is available for large shaft parts.



OIL MIST SEPARATOR

The mechanical oil mist separator cleans the aerosols which are generated in the work area during the machining process. High separation efficiency and an air flow of 1000 qm/h improve the indoor air quality.

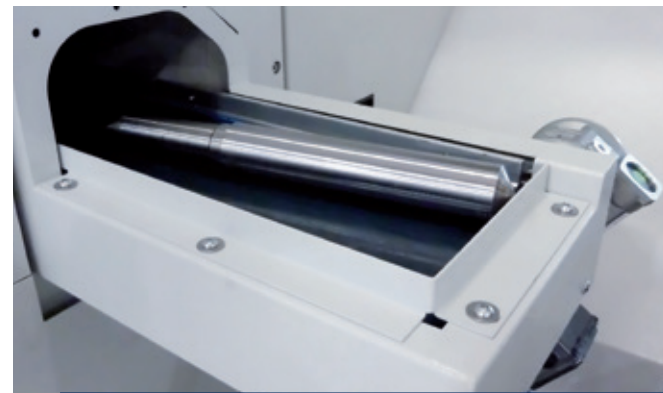

FINISHED PART CONVEYOR BELT

On the conveyor belt within the machine casing, arranged lengthwise, with a storage surface of 1400 x 180 mm, the workpieces are deposited damage free.

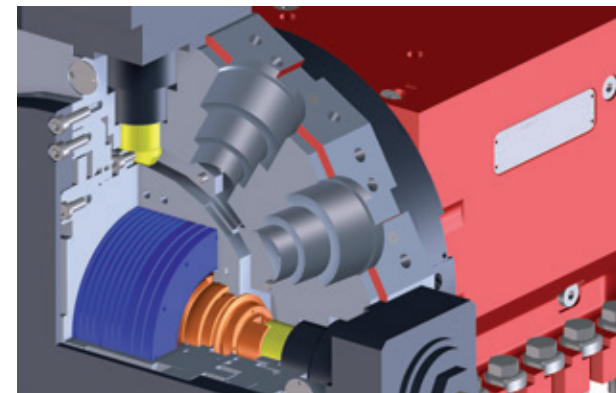

BMT TURRET

Economic production of elaborate turned/milled workpieces, the major part of which involves milling operations, are possible with the optionally available BMT turret with water-cooled direct drive. With a maximum of 12000 rpm, 30 Nm and 10 kW, this turret provides the ideal prerequisites for complete machining.



PAPER-BAND FILTER SYSTEM

A paper-band filter system for coolant processing is an advantageous solution for the serial production of turned/milled parts made of aluminium, brass, steel or grey cast iron. It increases both the coolant volume and the cooling lubricant's service life. Coolant pressures of 40, 60 or 80 bar can be implemented.

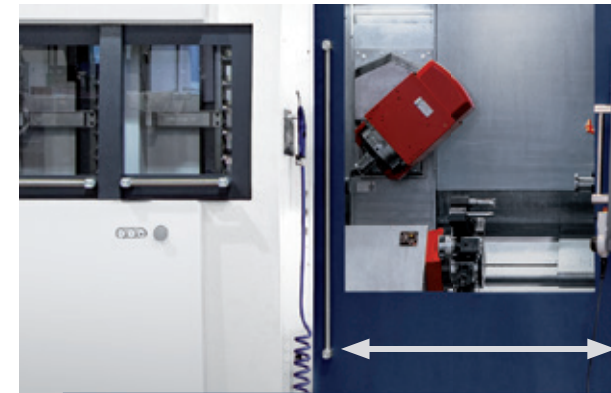

AUTOMATIC DOOR

Offering maximum comfort for manual workpiece loading, the fully automatic machine door is also the prerequisite for automatic, robot-assisted loading.

TECHNICAL DATA

Work area

Swing over bed	500 mm
Distance between spindle noses	1300 mm
Maximum turning diameter	500 mm
Max. part length	1040 mm
Max. bar-stock diameter	65 (76/95) mm

Travel

Travel X1 / X2	405 / 210 mm
Traverse path Z1 / Z2	1040 / 1050 mm
Traverse path Y1 / Y2	220 / 100 mm
Traverse path counter spindle Z3	1045 mm

Main spindle

Speed range (infinitely variable)	0 – 5000 (4000/3500) rpm
Maximum torque	250 (360) Nm
Spindle nose DIN 55026	A2-6 (A2-8)
Spindle bearing (inside diameter)	105 (130/140) mm
Spindle bore (excluding draw-back rod)	∅ 73 (86/106) mm

Counter spindle

Speed range (infinitely variable)	0 – 5000 (4000/3500) rpm
Maximum torque	250 (280) Nm
Spindle nose DIN 55026	A2-6 (A2-8)
Spindle bearing (inside diameter)	∅ 105 (130/140) mm

C-axis

Resolution	0,001°
Rapid traverse	1000 rpm

Drive power

Main spindle (AC integrated-spindle motor)	29 (37) kW
Counter spindle (AC integrated-spindle motor)	29 kW

Milling spindle – Powermill

Speed range	0 – 12000 rpm
Maximum torque	60 Nm
Maximum drive power	22 kW
Type of tool shank	HSK-T63

B-axis

Travel range	220°
Holding torque of clamp	4000 Nm
Interpolating drive torque	332 Nm

Tool magazine

Tool storage capacity	20 / 40 / 80 mm
Max. tool diameter	∅ 80 (∅ 120) mm
Max. tool length	250 mm
Max. tool weight	5 kg

Tool turret with BMT interface and direct drive

Number of tool positions	12
Precision interface	BMT-55P
Tool cross-section for square-shank tools	20 x 20 (25 x 25) mm
Shank diameter for boring bars	40 mm
Tool indexing time	0,5 sec.
Speed range of driven tools	0 – 12000 rpm
Torque of driven tools	30 Nm
Drive power of driven tools	10 kW

Feed drives

Rapid speed X1 / X2	30 m/min
Rapid speed Z1 / Z2 / Z3	30 m/min
Rapid speed Y1 / Y2	12 m/min
Feed force X1 / X2	5000 N
Feed force Z1 / Z2	8000 N
Feed force Y1 / Y2	7000 N

Coolant system

Tank capacity	450 (300) l
Coolant pumps for the tool systems	2 x 14 bar
Scavenge pumps for the work area	2 x 3,7 bar

Power consumption

Connected load	50 kVA
Compressed air	6 bar

Dimensions/weight

Height of center above floor	1316 mm
Overall height	2490 mm
Required space L x D (without chip conveyor)	5300 x 3340 mm
Total weight	12250 kg

Safety devices CE compliant

beyond standard /

EMCO GmbH / Salzburger Str. 80 / 5400 Hallein-Taxach / Austria / T +43 6245891-0 / F +43 624586965 / info@emco.at

www.emco-world.com